

DIMENSIONAL VIEWS

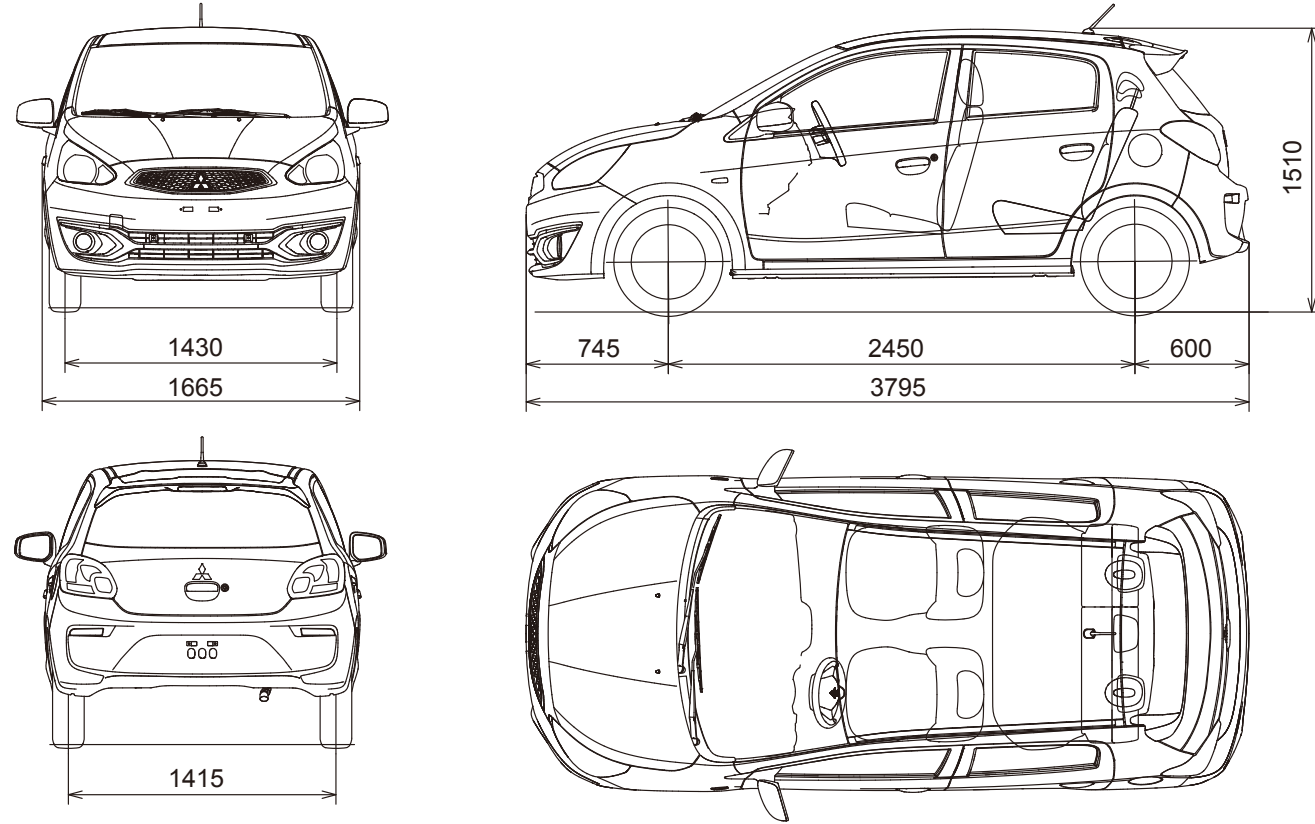

Note: Roof spoiler with high-mount stop lamp (LED), front separate low back seats and upgraded rear seat package are optional.

All measurements in millimeters



# SPACE STAR



[www.facebook.com/MitsubishiMotors.en](http://www.facebook.com/MitsubishiMotors.en)

[www.instagram.com/mitsubishimotorsofficial](http://www.instagram.com/mitsubishimotorsofficial)

[www.youtube.com/user/MitsubishiMotorsAd](http://www.youtube.com/user/MitsubishiMotorsAd)

**MITSUBISHI MOTORS**  
[www.mitsubishi-motors.com](http://www.mitsubishi-motors.com)

©2017-2018 MITSUBISHI MOTORS CORPORATION. All rights reserved.  
Gc/SE14C46Aug.17EG Printed in Japan



The paper used in this catalogue has been certified by the FSC™ (Forest Stewardship Council™) as having been produced through a 'chain of custody' system of forestry management, tracking and production oversight that ensures responsible consideration for the earth's ecosystem. Mitsubishi Motors has adopted the combined use of FSC-certified paper and recycled paper in our efforts to reduce CO<sub>2</sub> emissions and promote more efficient use of natural resources. In this way, we hope to contribute to greater protection of the environment.

[www.new-spacestar.com](http://www.new-spacestar.com)



## DISCOVER MORE OF LIFE'S LITTLE JOYS

Start every day fresh with spirited styling that inspires you to explore new horizons and lively response that puts a smile on your face. You'll also enjoy the smooth, comfortable ride, exceptionally stable handling and eco-friendly performance. It's the perfect, well-mannered travel companion.

1.2-liter MIVEC GLX shown with optional equipment / Black Mica [X08]

Note: Equipment may vary by market. Please consult your local Mitsubishi Motors dealer/distributor for details.



## EXPRESS YOUR FREEDOM AND STYLE

Dynamically styled from handsome face to expressive sides and contoured tail, the streamlined body blends refinement with athletic good looks to enhance the pleasure of confident motoring.

1.2-liter MIVEC GLX shown with optional equipment / Cool Silver Metallic [A66]

Note: Equipment may vary by market. Please consult your local Mitsubishi Motors dealer/distributor for details.





1.2-liter MIVEC GLX shown with optional equipment / Fabric seats (Black and Ivory)

## EMBRACE EVERY JOURNEY IN COMFORT

Step inside the cabin and discover refreshing driving pleasure. Comfort is enhanced by refined styling, ample spaciousness, clear visibility, high-quality amenities and a driver's seat with height adjustable seat cushion and headrest.





1.2-liter MIVEC GLX shown with optional equipment / Titanium Gray Metallic [U17]

## EXCITE YOUR SENSES RESPONSIBLY

Driving becomes a joy because both spirited performance and high fuel efficiency are delivered in full. Whether commuting to work, shopping in the city or traveling through the countryside, you'll enjoy sporty handling that is exceptionally stable, quick acceleration in response to your command and agile maneuverability that makes parking and sharp turns a breeze.



**1.2-LITER DOHC 12-VALVE MIVEC ENGINE**  
 Relish the power of a highly responsive 1.2-liter DOHC 12-valve MIVEC\* engine that delivers an ample maximum output of 57 kW (78 PS) at 6,000 rpm and practical maximum torque of 100 N-m (10.2 kg-m) at 4,000 rpm.  
 \* Mitsubishi Innovative Valve timing Electronic Control system

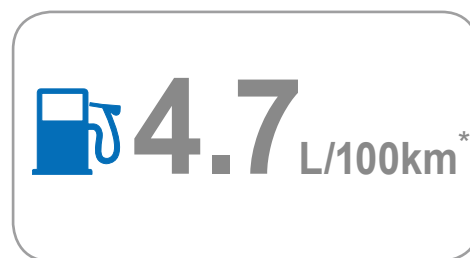

**CLASS-LEADING FUEL EFFICIENCY**  
 Traveling is especially affordable and eco-friendly. You'll enjoy longer drives with fewer petrol stops, thanks to class-leading fuel efficiency.  
 \* Fuel consumption when equipped with 14" tires. According to internal test results using EU Combined cycle.



**SMOOTH AERODYNAMIC DESIGN**  
 The streamlined body smoothly slips through the wind with a class-leading drag coefficient of  $C_d=0.30^*$  that lowers wind noise and CO<sub>2</sub> emissions while raising fuel efficiency and high-speed stability.  
 \* According to internal test results.

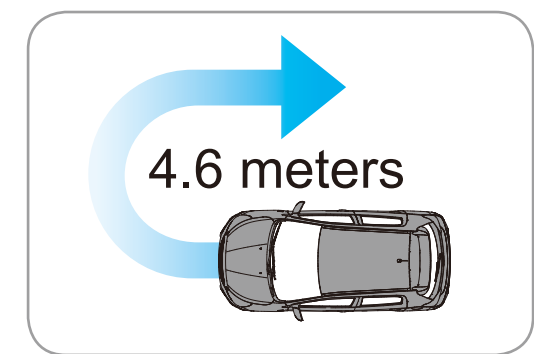

**A MINIMUM TURNING RADIUS AMONG THE SMALLEST IN ITS CLASS**  
 The tight turning radius contributes to excellent handling and makes driving easy for anyone, at any age.



**INVECS-III CVT**  
 The INVECS-III\* CVT wide-ratio transmission maintains optimal rpm for high performance and fuel economy. You'll enjoy smooth acceleration and deceleration, as well as efficiently selected gear ratios in all driving conditions. An illuminated indicator provides easy reading at a glance and the shift knob is leather-wrapped for your pleasure.  
 \* Intelligent & Innovative Vehicle Electronic Control System III

Note: Equipment may vary by market. Please consult your local Mitsubishi Motors dealer/distributor for details.

# CONVENIENCE

## EQUIPMENT HIGHLIGHTS

The cockpit surrounds you with convenient amenities. Whether storing personal items or adjusting the temperature, music or seats, you'll find every detail is designed to enhance the user experience.



### SEMI-HIGH-CONTRAST COMBINATION METER WITH CHROME SURROUNDS

The meters are large and easy to read with continuous illumination and a silver garnish to enhance your enjoyment. Adjustable brightness contributes to easy reading at a glance in any lighting.

\* Actual appearance may vary.



DOOR MIRROR WITH SIDE TURN LAMP



ELECTRIC ADJUSTABLE DOOR MIRRORS



TILT ADJUSTABLE STEERING COLUMN



GLOVE BOX AND TRAY



MANUAL AIR-CONDITIONING

Finely adjust air-conditioning with user-friendly controls.

### GENERAL-PURPOSE MONITOR: MULTI-INFORMATION DISPLAY

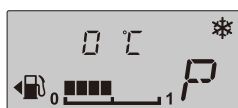

Outer temperature / Frost alert

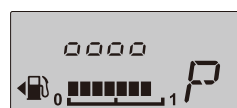

Meter illumination control



Driving range display



Average fuel consumption



Service reminder (in distance)



CD PLAYER WITH UNIQUE TYPE CENTER PANEL

This unique system includes a CD player and AM/FM radio.



1-DIN AUDIO WITH CD AND AM/FM RADIO

Mount the audio system of your choice in this center panel.



AUDIO SYSTEM WITH CLOCK



FOLDABLE SPLIT BACK (60:40) BENCH SEAT



HANDS-FREE SYSTEM AND AUDIO CONTROLS

Convenient controls for the audio system and Bluetooth® hands-free mobile phone system are mounted on the steering wheel for easy-to-reach access.

Note: Bluetooth is a trademark of Bluetooth SIG, Inc.

Note: Equipment may vary by market. Please consult your local Mitsubishi Motors dealer/distributor for details.



USB PORT

Designed for easy connection with digital audio players, etc.



CONVENIENCE HOOK



CUP HOLDERS



FRONT DOOR POCKET WITH BOTTLE HOLDER



1.2-liter MIVEC GLX shown with optional equipment / Sunrise Orange Metallic [M09]

## SAFETY

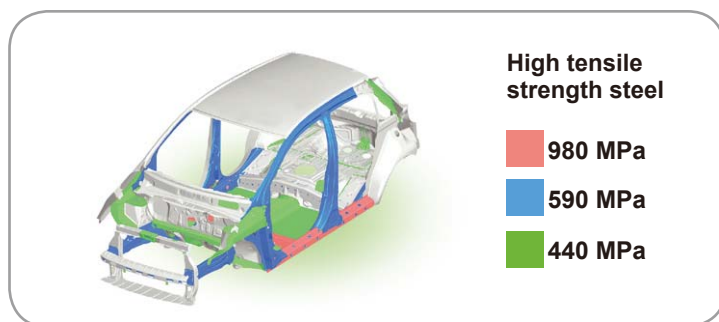

### RISE BODY

The body is extremely sturdy and lightweight, thanks to the generous use of high tensile strength steel plates that also contribute to a high level of collision safety.



### DRIVER AND PASSENGER SRS AIRBAGS

Front SRS airbags reduce collision impact, helping to curb injuries to the driver and front passenger in the event of a collision.

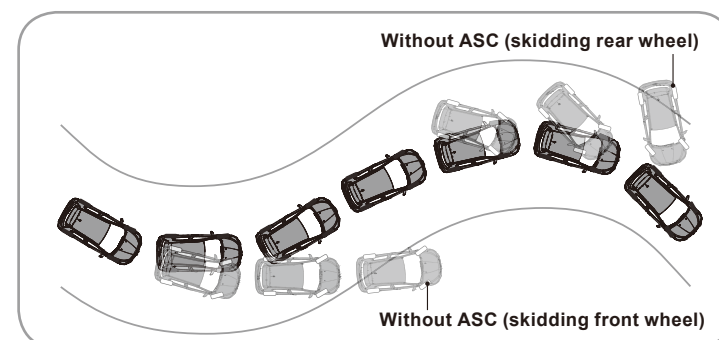

### ACTIVE STABILITY CONTROL (ASC)

If wheels lose their grip on slippery surfaces or while turning, ASC automatically adjusts engine output and applies braking force at the appropriate wheels to help maintain control and prevent skidding.



### HILL START ASSIST (HSA)

When starting on a steep slope, HSA helps prevent you from rolling backwards while you release the brake by maintaining the braking force for up to two seconds until the accelerator is applied.

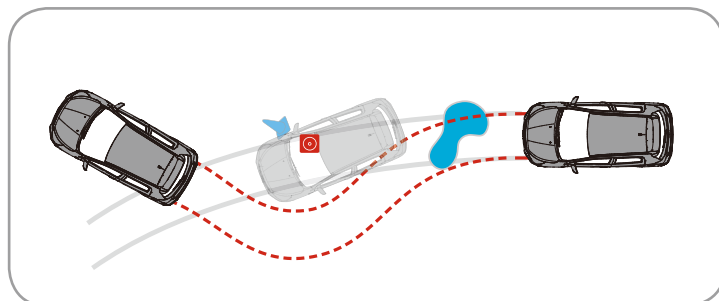

### 4ABS

The four-wheel anti-lock brake system helps prevent the wheels from locking up during emergency braking so you can maintain greater steering control, even on slippery roads.

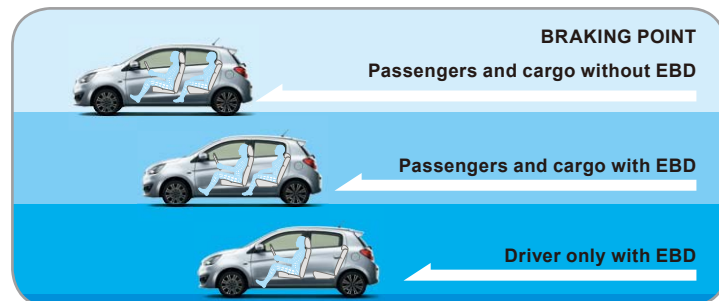

### EBD

Electronic Brake-force Distribution distributes braking force to all four wheels to enhance braking performance.

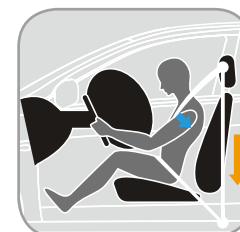

### PRETENSIONERS

Pretensioners automatically tighten the front seatbelts in the event of a collision to help restrain the driver and front passenger.



### TIRE PRESSURE MONITORING SYSTEM (TPMS)

TPMS employs sensor-transmitters in the wheels to monitor tire pressure and illuminates a warning lamp on the combination meter cluster if one or more tires become significantly underinflated.



### POWER WINDOW

The driver's side window can be raised or lowered with a single touch and features an anti-trap mechanism for safety.

Note: Equipment may vary by market. Please consult your local Mitsubishi Motors dealer/distributor for details.

# INTELLIGENCE

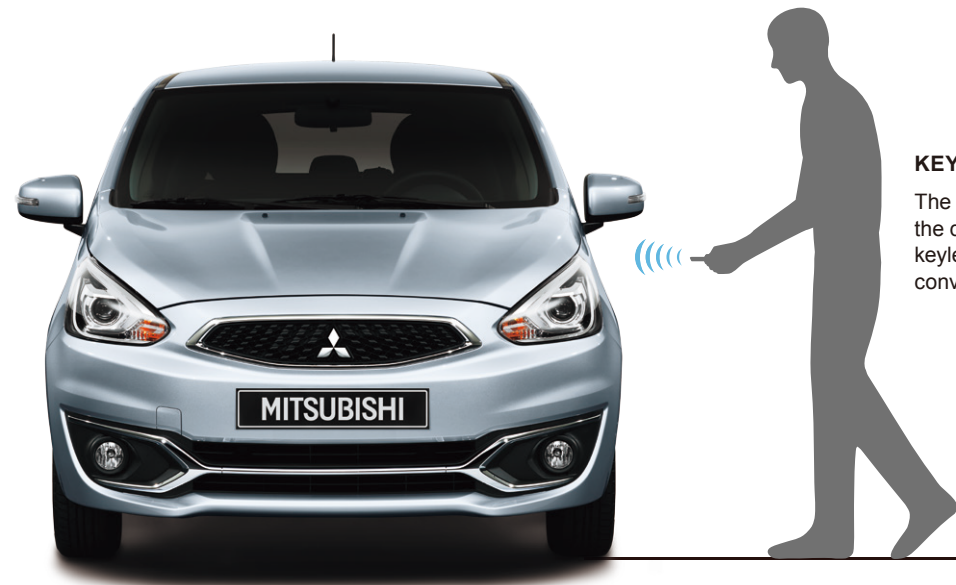

### KEYLESS ENTRY SYSTEM

The keyless entry system lets you lock or unlock the doors and tailgate with the press of a keyless entry key. Two keys are provided for the convenience of couples.

## ETACS (Electronic Time and Alarm Control System)

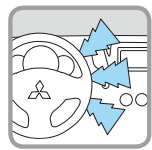

### LANE CHANGE TURN SIGNAL SYSTEM

When changing lanes, you can lightly touch the turn signal lever to flash the turn signals three times. Flashing is also indicated on the instrument panel.



### POWER WINDOW TIMER

Even after shutting off the engine, the power windows can be opened or closed for 30 seconds before opening the door.

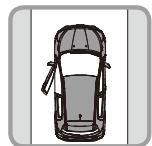

### HEADLAMP AUTO OFF FUNCTION

After switching off the ignition and stepping out of the car, the headlamps automatically turn off to help conserve battery power.

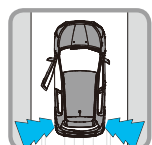

### OPEN DOOR ALARM

An alarm sounds automatically if you start driving while a door remains partially or fully open.



### AUTO DOOR RELOCK SYSTEM

Within 30 seconds of pressing the unlock button from outside the car, this system will automatically relock all the doors if none have been opened.

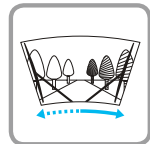

### AUTO SPEED ADJUSTABLE WIPERS

In the Timing mode, the window wipers operate normally at vehicle speeds below 60km/h and faster at higher vehicle speeds.



### AUTO REAR WIPE FUNCTION FOR REVERSE

When the rear wiper is set to the "INT" (intermittent) position, it automatically activates to improve rear visibility whenever you shift into reverse.



### INTERIOR LIGHT DELAY

After turning off the ignition, the interior light remains on for 15 seconds to allow scanning for possessions before exiting.

## EQUIPMENT LEVEL

# GLX



### Key features

#### Standard:

- 165/65R14 tires + 14" steel wheels with wheel center caps
- Anti-lock Brake System (ABS) with Electronic Brake-force Distribution (EBD)
- Active Stability Control (ASC)
- Brake Assist
- Hill Start Assist (HSA)
- Tire Pressure Monitoring System (TPMS)
- SRS airbags (driver and front passenger)
- Immobilizer
- Halogen headlamps
- Color-keyed outer door handles and tailgate handle
- Color-keyed power door mirrors
- Front variable intermittent windshield wipers & washers
- Tilt column steering

- Urethane parking brake lever
- Tachometer
- Multi-information display
- Slide & reclining adjuster (driver & passenger)
- Foldable bench seat
- Passenger's side sunvisor
- Room lamp
- Windshield & side defroster
- Manual air-conditioning (3-dial type controller)
- Air filter

#### Optional, shown:

- 165/65R14 tires + 14" steel wheels with full wheel covers
- Roof spoiler with high-mount stop lamp (LED)
- Separate, low back seats (driver & passenger)
- Headrests (driver & passenger)
- Height adjustable driver's seat
- Convenience hook & seatback pocket (passenger's seat)
- Accessory socket on instrument panel
- Rear shelf board
- Keyless entry with 2 transmitters
- Speaker x 2 (on front doors)
- 2-DIN center panel + 1-DIN AM/FM & CD player with 1-DIN box
- USB port (on floor console tray with lid)

Note: For a complete list of standard and optional equipment, please refer to pages 17 and 18.



## EXTERIOR COLORS



WINE RED PEARL (P57)



SUNRISE ORANGE METALLIC (M09)



RED METALLIC (P19)



MEDIUM BLUE MICA (T69)



TITANIUM GRAY METALLIC (U17)



COOL SILVER METALLIC (A66)



BLACK MICA (X08)



WHITE PEARL (W54)



WHITE SOLID (W19)

## INTERIOR COLORS

### SEAT MATERIALS



Fabric (Ivory)



Fabric with stitches

■ Standard □ Optional

Grade		GLX	
		Black & Ivory	
Interior trim		Black & Ivory	Black & Ivory with stitches
<b>Seats</b>			
<b>Exterior Color</b>			
Wine Red Pearl	P57	■	□
Sunrise Orange Metallic	M09	■	□
Red Metallic	P19	■	□
Medium Blue Mica	T69	■	□
Titanium Gray Metallic	U17	■	□
Cool Silver Metallic	A66	■	□
Black Mica	X08	■	□
White Pearl	W54	■	□
White Solid	W19	■	□

Note: Colors shown may differ slightly from actual colors due to printing process.

Note: Equipment may vary by market. Please consult your local Mitsubishi Motors dealer/distributor for details.

## TECHNICAL SPECIFICATIONS

Model	Grade	Transmission	Model code	GLX
				CVT
				A03AXTMHLW
<b>Dimensions and Weights</b>				
Overall length		mm		3,795
Overall width		mm		1,665
Overall height		mm		1,510
Wheelbase		mm		2,450
Ground clearance		mm		160
Curb weight (total)		kg		880
Gross vehicle weight (GVW)		kg		1,320
Seating capacity		persons		5
<b>Performance</b>				
Fuel consumption* [with 14" tires (15" tires)]		liter/100km		4.7 (4.9)
Max. speed**		km/h		167
Acceleration (0-100 km/h)**		sec.		13.8
Min. turning radius		m		4.6
<b>Engine</b>				
Type (code)				1.2-liter 12-valve 3-cylinder DOHC MIVEC (3A92)
Total displacement		cc		1,193
Emission level				EURO-4
Max. output (EEC net)		kW (PS)/rpm		57 (78)/6,000
Max. torque (EEC net)		N-m (kg-m)/rpm		100 (10.2)/4,000
<b>Fuel System</b>				
Fuel supply system				ECI-MULTI (Electronic Controlled Injection – Multi Point Injection)
Fuel tank capacity		liter		35
<b>Transmission</b>				
Type				INVECS-III CVT
<b>Steering</b>				
Type				Rack and pinion with electric power assist
<b>Suspensions</b>				
Front				MacPherson strut
Rear				Torsion beam
<b>Brakes</b>				
Front				Ventilated discs
Rear				Leading and trailing drums
<b>Tires</b>				
Tires (front and rear)	Standard			165/65R14
	Option			175/55R15
Wheels (front and rear)	Standard			14" steel with center caps
	Option			14" steel with full wheel covers / 15" alloy wheels

\* According to internal test results using EU Combined cycle.

\*\* Measured by Mitsubishi Motors Corporation.

Note: These specifications are subject to change without notice. Please consult your local Mitsubishi Motors dealer/distributor for detailed specifications.

**STANDARD & OPTIONAL EQUIPMENT**

■ Standard □ Optional

Model	Grade		GLX
	Engine	Transmission	1.2-liter MIVEC CVT
<b>Performance</b>	Engine	1.2-liter 12-valve 3-cylinder DOHC MIVEC (3A92)	■
	Transmission	INVECS-III CVT (continuously variable transmission)	■
	Tires & wheels	165/65R14 tires + 14" steel wheels with wheel center caps	■
		165/65R14 tires + 14" steel wheels with full wheel covers	□
		175/55R15 tires + 15" alloy wheels	□
Spare tire & wheel	165/65R14 tire + 14" steel wheel	■	
	175/55R15 tire + 15" alloy wheel	□	
<b>Safety</b>	Brakes	Front: Disc (ventilated) Rear: Drum (leading & trailing)	■
		Anti-lock Brake System (ABS) with Electronic Brake-force Distribution (EBD)	■
		Active Stability Control (ASC)	■
		Brake Assist	■
		Hill Start Assist (HSA)	■
	SRS airbags	Driver & front passenger	■
	Front seatbelts	3-point ELR seatbelt with single pretensioner (driver & passenger)	■
	Rear seatbelts	3-point seatbelt with ELR x 2 + 2-point lapbelt x 1 (center)	■
	Exterior lamps	Tailgate with high-mount stop lamp (bulb type)	■
	Theft protection	Immobilizer	■
	Other	Tire Pressure Monitoring System (TPMS)	■
<b>Exterior</b>	Bumpers	Front and rear: color-keyed	■
		Foglamp bezel on front bumper	□
		Front under grille (material black)	■
		Front under grille (chrome)	□
	Headlamps	Bi-xenon HID headlamps with manual leveling and LED position lamps	□
		Halogen headlamps	■
	Fog lamps	Front fog lamps	□
		Rear fog lamp on rear combination lamp (driver's side)	■
	Glass	Laminated windshield glass	■
		Tempered front & rear door window glass	■
		Tempered tailgate window glass with defogger	■
	Front wipers	Variable intermittent windshield wipers & washers	■
	Rear wiper	Intermittent wiper & washer	□
	Doors	Color-keyed outer door handles	■
		Black door sash	□
	Door mirrors	Color-keyed power door mirrors	□
		Color-keyed power door mirrors with side turn lamp	■
Molding	Roof molding (black)	■	
Tailgate	Color-keyed tailgate handle	■	
	LED rear combination lamps	□	
Other	Roof spoiler with high-mount stop lamp (LED)	□	
<b>Cockpit</b>	Steering & shift knob	Electric power steering	■
		Tilt column steering	■
		Shift lock with key interlock	■
		3-spoke urethane steering wheel with bezel	■
		3-spoke leather wrapped steering wheel with piano black & chrome decoration	□
		Urethane gearshift knob	■
		Leather wrapped gearshift knob	□
	Instrument panel	Urethane parking brake lever	■
		Combination meter	■
		Semi-high contrast combination meter with chrome surrounds	□
		Tachometer	■
		Gear shift indicator panel with illumination: silver	■
		Gear shift indicator panel with illumination: piano black	□
Multi-information display	Service reminder, Trip computer – driving range & average fuel consumption, illumination control, etc.	■	
<b>Seats</b>	Seat materials	Fabric	■
		Fabric with stitches	□
	Front seats	Separate, high back seats	■
		Separate, low back seats	□
	Headrests	Driver and passenger	□
		Driver's seat	Slide & reclining adjuster
		Height adjustable driver's seat	□
	Passenger's seat	Slide & reclining adjuster	■
		Convenience hook & seatback pocket	□
	Rear seats	Foldable bench seat	■

**STANDARD & OPTIONAL EQUIPMENT**

■ Standard □ Optional

Model	Grade		GLX
	Engine	Transmission	1.2-liter MIVEC CVT
<b>Interior</b>	Doors	Material black inner door handles	■
		Chrome inner door handles	□
	Instrument panel	Piano black power window switch panels	□
		Glove box	■
		Tray on instrument panel	■
		Center panel (piano black)	■
		Cigarette lighter on instrument panel	□
	Floor console	Accessory socket on instrument panel	□
		Front: cup holder x 2	■
		Rear: cup holder x 1	■
	Front door trim	Ashtray	□
	Ceiling	Door pocket & bottle holder (both sides)	■
		Driver's side sunvisor with vanity mirror, lid & ticket holder	■
		Passenger's side sunvisor	■
		Day & night rear view mirror	■
		Front passenger's assist grip	■
		Rear assist grips	■
	Interior lamps	Room lamp	■
		Luggage room lamp	□
Others	Rear shelf board	□	
	Tool set (simple set), jack set & tire pressure gauge	■	
	Fire extinguisher, first aid kit & emergency triangle	■	
<b>Comfort and Convenience</b>	Air-conditioning	Windshield & side defroster	■
		Manual air-conditioning (3-dial type controller)	■
		Air filter	■
Locking system	Keyless entry with 2 transmitters	□	
	Secondary key (1 piece)	□	
	Central door locking system	□	
	Child proof	■	
Doors	Power windows (front doors)	■	
	Front and rear power windows with auto up & down function on driver's side (anti-trapping function)	□	
Steering switch	Audio switches	□	
	Audio and hands-free phone switches	□	
<b>Audio and Media</b>	Speakers & antenna	Speaker x 2 (on front doors)	□
		Speaker x 4 (on front & rear doors)	□
		Roof antenna	■
	Audio system (& center panel)	2-DIN center panel without audio	■
2-DIN center panel + Audio pre-kit with 1-DIN box & plug		□	
2-DIN center panel + Audio pre-kit with plug		□	
2-DIN center panel + 1-DIN AM/FM & CD player with 1-DIN box		□	
AM/FM radio and CD player with unique type center panel		□	
	USB port (on floor console tray with lid)	□*1	
	Bluetooth® hands-free phone system*2	□*1	
<b>Package Option</b>	Upgraded rear seat package	Foldable split back (60:40) bench seat	■
		Headrest x 3	□
		3-point ELR seatbelt x 3	□
		Lower anchor and tether anchor for ISO-FIX child seat x 2	□

\*1 Must be combined with AM/FM radio and CD player with unique type center panel  
 \*2 Bluetooth is a trademark of Bluetooth SIG, Inc.