

### DIMENSIONAL VIEWS

7-seater

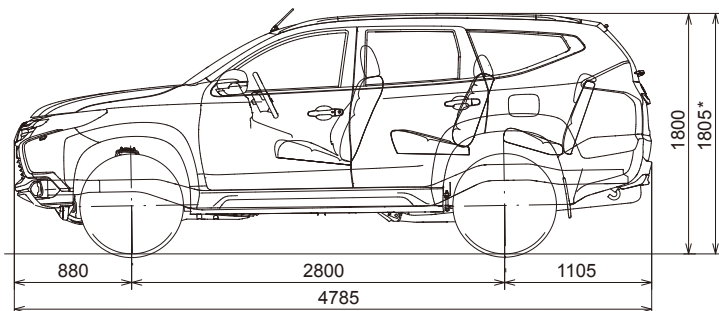
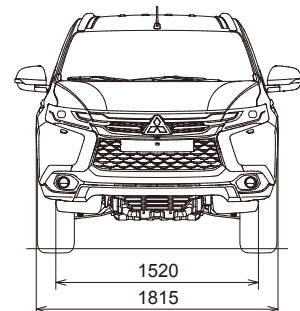
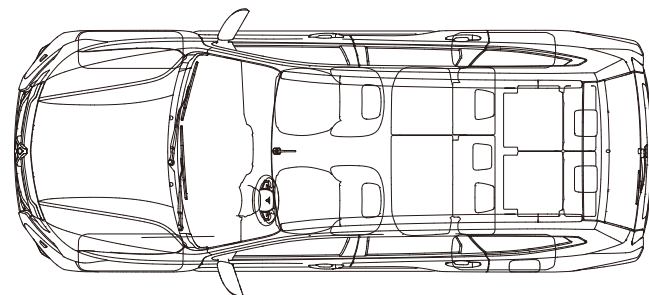
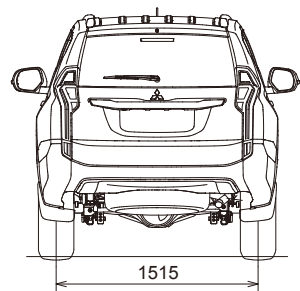

\* With roof rails

Note: Glass antenna is optional.

All measurements in millimeters



# MONTERO SPORT



 [www.facebook.com/MitsubishiMotors.en](http://www.facebook.com/MitsubishiMotors.en)

 [www.youtube.com/user/MitsubishiMotorsAd](http://www.youtube.com/user/MitsubishiMotorsAd)

 **MITSUBISHI MOTORS**  
[www.mitsubishi-motors.com](http://www.mitsubishi-motors.com)



The paper used in this catalogue has been certified by the FSC™ (Forest Stewardship Council™) as having been produced through a 'chain of custody' system of forestry management, tracking and production oversight that ensures responsible consideration for the earth's ecosystem. Mitsubishi Motors has adopted the combined use of FSC-certified paper and recycled paper in our efforts to reduce CO<sub>2</sub> emissions and promote more efficient use of natural resources. In this way, we hope to contribute to greater protection of the environment.

©2016–2017 MITSUBISHI MOTORS CORPORATION. All rights reserved.  
Gc/ME35C160Feb.17T Printed in Japan

[www.new-monterosport.com](http://www.new-monterosport.com)



# FIND THE FAR BEYOND.

The world is yours in the new MONTERO SPORT. Whether confidently exploring rough terrain in the wilderness or attracting admiration on city streets, you'll be traveling first class all the way.



GLS Premium with optional equipment / Sterling Silver Metallic (U25)





## TASTEFULLY ROBUST

Discover the new look of 4WD luxury. Boldly sculpted and stylishly accented, the assertive aerodynamic body delivers solid refinement down to the last detail — from Dynamic Shield front design concept to vibrant rear lamps. So you can seize every adventurous opportunity with style.

GLS Premium with optional equipment / Deep Bronze Metallic (C17)







## PREMIUM COMFORT

Adventure calls from the well-appointed cockpit, which surrounds you with solid craftsmanship, supportive comfort, intelligent features and a wide open view. From refined meters to sophisticated floor console, every feature is fine-tuned to enhance driving pleasure and keep you in confident control.

GLS Premium Navi Package / Leather (Beige)





GLS Premium Navi Package / Leather (Beige)

## PLEASANT JOURNEYS

Every guest feels special in the luxurious interior. From leather seats with smooth gathers and dual layered cushioning to relaxing spaciousness and an optimized driving position, it keeps everybody comfortable and in the best of spirits.





**SUPER SELECT 4WD-II**  
C/D LOCK **2H**  
For normal road conditions

**SUPER SELECT 4WD-II**  
C/D LOCK **4H**  
For rough roads and hazardous conditions

**SUPER SELECT 4WD-II**  
C/D LOCK **4HLC**  
For rugged terrain with low-grip surfaces

**SUPER SELECT 4WD-II**  
C/D LOCK **4LLc**  
For rocks, mud, sand, deep snow, etc.



## SUPER SELECT 4WD-II



Using the drive mode selector dial, you can switch between 2WD (2H) and 4WD (4H, 4HLC) with shift-on-the-fly convenience at up to 100km/h. When the going gets rough, lock the center differential by entering the 4HLC setting for rugged terrain or the 4LLc setting for inclines, mud, sand and snow.

Note: The vehicle must be stopped while switching between 4HLC and 4LLc. Super Select 4WD-II lets you shift between 2H, 4H and 4HLC modes at speeds up to 100km/h. Vehicle must be stopped when switching between 4HLC and 4LLc. Please see the owner's manual for additional information.

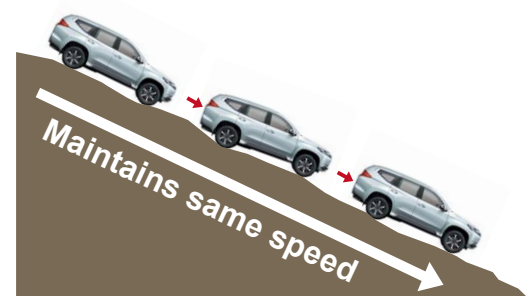

### Hill Descent Control (HDC)

Pressing the HDC mode selector activates HDC, which automatically applies the brakes to maintain your current speed when traveling downhill at 2 ~ 20km/h. This lets you concentrate on steering and travel downhill with greater safety without having to manually apply the brakes.

Note: Hill Descent Control (HDC) is not a substitute for safe driving. Never rely solely on this function while driving on steep roads. When driving on slippery roads such as muddy, icy or unpaved road, your vehicle will not allow you to stay at a certain low speed, which may lead to a serious accident. Please see the owner's manual for additional information.

## Solid Handling

Handling is stable and accurate on and off road, in all kinds of weather and driving conditions, thanks to selectable 2WD and 4WD modes, an OFF ROAD MODE that enhances traction on demanding surfaces, intelligent assistance in challenging conditions, an advanced suspension and outstanding all-around clearance.



**OFF ROAD MODE**



### OFF ROAD MODE

Improve traction when driving off road by entering the GRAVEL, MUD/SNOW, SAND or ROCK\* setting. Simply press the OFF ROAD MODE selector until the appropriate mode appears in the multi-information display. Engine output, transmission settings and braking adjust accordingly to optimize performance.

\* The ROCK setting is available in the 4LLc setting only. Note: OFF ROAD MODE is only available in the 4HLC and 4LLc settings.



### Hill Start Assist (HSA)

When starting on a steep slope, HSA helps prevent you from rolling backwards while you release the brake by maintaining the braking force for up to two seconds until the accelerator is applied.



With Hill Start Assist

Without Hill Start Assist

Note: Hill Start Assist (HSA) is not a substitute for safe driving. Never rely solely on this function while driving on steep roads. Your vehicle may move backwards if the brake pedal is heavily loaded, or if the road is very steep or slippery. This function is not designed to keep the vehicle stopped in place on uphill slopes for more than 2 seconds. Do not rely on this function to maintain a stopped position as an alternative to depressing the brake pedal. Please see the owner's manual for additional information.

### Active Stability & Traction Control (ASTC)

Active Stability & Traction Control independently regulates braking force to the wheels during cornering to help maintain excellent vehicle stability when needed. It also optimizes traction to prevent loss of torque whenever wheel spin is detected by controlling engine output and applying brake force to the spinning wheels.

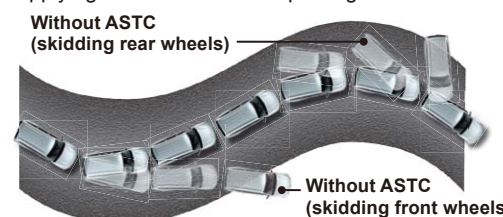

Note: The control capabilities of ASTC are supplemental only. Please drive safely and never rely solely on these functions while driving. Be sure to use the same specified type and size of tires on all 4 wheels. Do not install any aftermarket limited slip differential on your vehicle. Please see the owner's manual for additional information.

### Class-leading 5.6m turning radius

The turning radius is surprisingly small for a vehicle of this size, making it especially easy to park and maneuver.



### All-terrain confidence

Because challenges come in all shapes and sizes, this model is designed to climb up, over, around and through the toughest terrain.

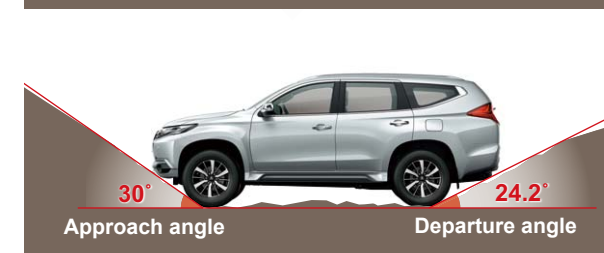



# Dynamic Power

Whether passing vehicles on highways or traveling up steep slopes, you need powerful response you can depend on. The 3.0-liter V6 MIVEC\* gasoline engine generates all the power you demand of a rugged SUV to accomplish every mission with smooth, efficient ease.

\* MIVEC (Mitsubishi Innovative Valve timing Electronic Control system)



## 3.0-liter V6 MIVEC

Tough and powerful, the high-displacement V6 engine supplies strong acceleration even when carrying heavy loads or traveling up mountain roads.

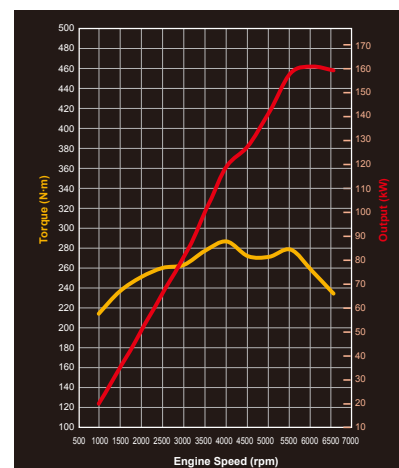

3.0-liter V6 MIVEC (Euro2 161kW/6000rpm)



## 8-speed automatic transmission

The 8-speed automatic transmission, the first from Mitsubishi Motors, delivers a smoother, more luxurious ride and improved fuel efficiency.



## Paddle shifters

Sporty paddle shifters let you shift gears with a press, without removing your hand from the steering wheel.



GLS Premium with optional equipment / Deep Blue Mica (T64)



# Technology For Peace Of Mind

Sophisticated new safety features intelligently support safer driving whether you are parking or cruising on the highway. You can drive with greater confidence knowing that all occupants are solidly protected by a robust RISE body and comprehensive safety measures.

## Multi-around Monitor

The views from cameras mounted on the front, rear and sides of the vehicle (including a bird's-eye view) can be displayed in various combinations to reveal what is in blind spots and help you park more safely.



Rear view + Bird's-eye view



## RISE body

Collision safety performance is significantly enhanced by Mitsubishi Motors' RISE (Reinforced Impact Safety Evolution) body, which efficiently absorbs energy and maintains high cabin integrity in the event of a collision.

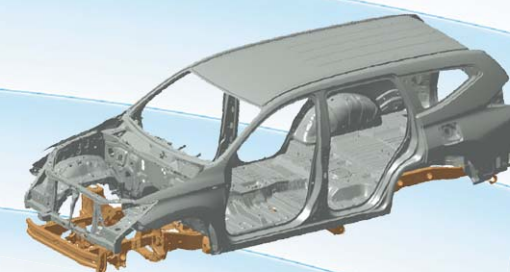

## Rigid lightweight body

The body is extremely sturdy and lightweight, due to the generous use of high tensile strength steel plates that also contribute to a high level of collision safety.

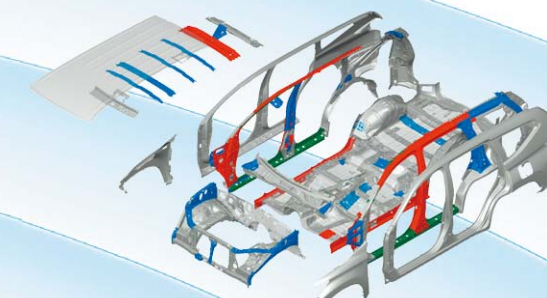

## Blind Spot Warning system (BSW)

This safety feature uses ultrasonic sensors on the rear bumper to detect vehicles in your rear blind spots, on the right and left sides. When a vehicle is detected, a warning indicator appears on the door mirror on that side.



## Ultrasonic misacceleration Mitigation System (UMS)

To help prevent collisions while parking, this system sounds a buzzer and displays a warning if front or rear sensors detect a nearby obstacle in your path. Engine output is also automatically controlled if you suddenly accelerate by accident.

Engine output control activates:

- When driving at 0-10km/h (not in N or P position)
- When obstacle/vehicle is within approx. 4m range
- When accelerator pedal is pushed hard or abruptly
- When driver is not turning to avoid obstacle/vehicle



## Forward Collision Mitigation system (FCM)

Helps prevent a frontal collision or reduce damage if the collision becomes unavoidable. Responds to vehicles via radar.

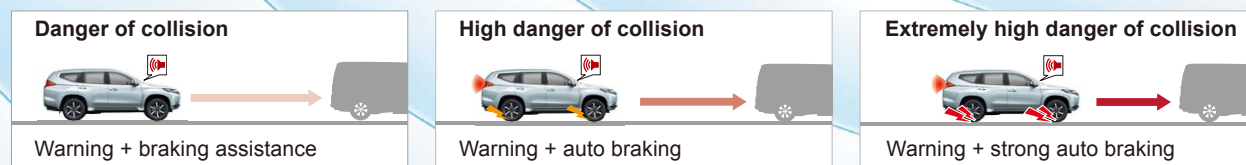

FCM indication on multi-information display **BRAKE!**

## Tire Pressure Monitoring System (TPMS)

TPMS employs sensor-transmitters in the wheels to monitor tire pressure and illuminates a warning lamp on the combination meter cluster if one or more tires becomes significantly underinflated.



## Adaptive Cruise Control (ACC)

Maintains a selected distance between your vehicle and the car ahead via radar to lend driving assistance and enhance driving comfort. It especially reduces driver stress during slow traffic jams on highways.



Your selected speed is maintained even if you remove your foot from the accelerator pedal.

Your selected distance between vehicles is maintained.

When the vehicle in front slows or stops, ACC slows or stops your vehicle.

Note: The detection and control capabilities of ACC are supplemental only. Please drive safely and never rely solely on these functions while driving. ACC may not activate in some situations. This system may not correctly detect the actual situation depending on the type of vehicle in front and its conditions, the weather conditions, and the road conditions. Additionally, the system may be unable to decelerate sufficiently if the vehicle in front applies the brakes suddenly or another vehicle cuts into your path, so your vehicle approaches the front vehicle. When the car stops, ACC finishes its control and the brake is released approximately 2 seconds after stopping. To prevent the vehicle from moving thereafter, the driver may have to hold the brake pedal down. Please see the owner's manual for additional information.

## 7 SRS airbags\*

In the event of a collision, seven SRS airbags help protect you and your passengers by absorbing the force of impact. The system includes front airbags, front side airbags, curtain airbags (including third-row curtain airbags in the 7-seater) and a driver's knee airbag.

\*Front airbags on all grades. Side, curtain and driver's knee airbags on GLS Premium.



Note: Airbags are part of a Supplemental Restraint System (SRS). To decrease the risk of injury from a deploying airbag, always wear your seatbelt, sit upright in the middle of the seat and do not lean against the door. Always place children 12 and under in the rear seat and use appropriate child restraints. Never place a rear-facing infant restraint in the front seat. Please see the owner's manual and the instructions provided with your child restraint for additional information.

## Pretensioners

Pretensioners on the front seatbelts automatically tighten the belts in the event of a collision to help restrain the driver and front passenger.

Note: Single pretensioners are standard, double pretensioners are optional.



Note: The detection and control capabilities of the Blind Spot Warning system (BSW) are supplemental only and do not warn you of vehicles in blind spots in every situation. Please do not rely solely on this system while driving. The blind spot monitor may not operate normally in some cases, depending on traffic, weather, road surface conditions and the presence of obstructions. Drivers are fully responsible for their own safe driving. The radar wave graphics are used for illustrative purposes only and do not represent the actual sensor application.

The detection and control capabilities of the Ultrasonic misacceleration Mitigation System (UMS) are supplemental only and do not prevent misacceleration in every situation. Please drive safely and do not rely solely on this system while driving. • To prevent the engine output control provided by UMS from causing an impediment during normal driving in rough-road driving conditions, the system automatically de-activates and indicates UMS OFF in the meter cluster when the 4LLc, R/D lock, or HDC setting is ON or the ASTC function is OFF. • No function completely stops the vehicle via the automatic braking. The vehicle creeps forward even when engine output is regulated. • The sensing system may not work for netlike and sharp-edged obstructions that do not sufficiently reflect ultrasonic sound. • UMS does not include a function which keeps the vehicle stationary. The driver is responsible for stopping the vehicle by pressing the brake pedal as required by the driving conditions. • The ultrasonic sensor wave graphics are for illustrative purposes only and do not represent the actual sensor application.

The detection and control capabilities of the Forward Collision Mitigation system (FCM) are supplemental only and do not prevent collisions in every situation. Please drive safely and do not rely solely on this system while driving. FCM may not activate in some situations. Please read the owner's manual carefully and be aware of these limitations. Auto braking does not operate against stationary vehicles when the speed of your car is above approx. 30km/h. Since FCM has no function to maintain braking, the brake is released approximately 2 seconds after stopping. To prevent the vehicle from moving thereafter, the driver may have to hold the brake pedal down. In some cases, FCM may not function if the driver takes actions for accident avoidance through steering or acceleration operation.





## Feature Highlights



### LED headlamps and daytime running lamps

Sophisticated LED headlamps and daytime running lamps contribute to an appealing, high-quality personality.

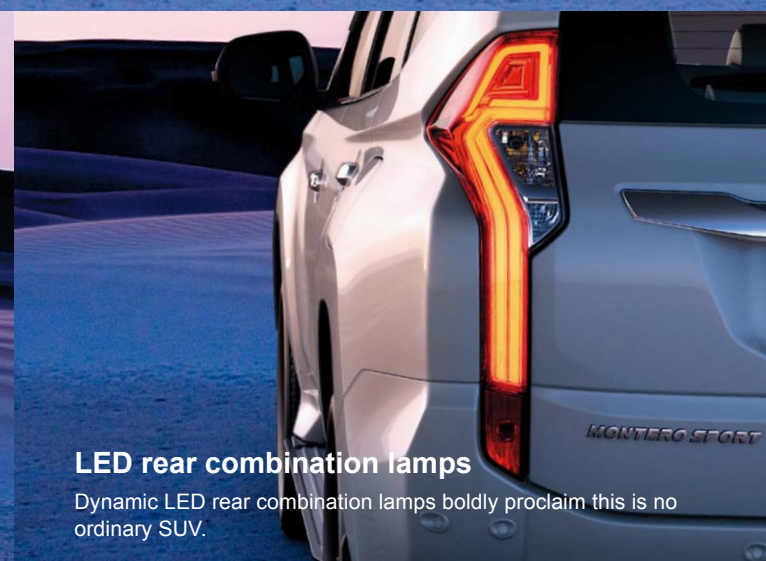

### LED rear combination lamps

Dynamic LED rear combination lamps boldly proclaim this is no ordinary SUV.



265/60R18 tire with 18-inch alloy wheel (two tone)

265/60R18 tire with 18-inch alloy wheel



### High-contrast meters and multi-information display



### Steering switches



### Electric parking brake

The parking brake is easy to operate via stylish switch. Simply pull the switch up to apply the parking brake or push the switch down to release it.



### Sunglasses pocket



### Floor console

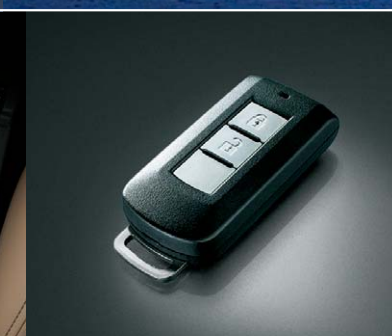

### Keyless operation key



### Engine switch





## Feature Highlights



### Dual-zone automatic climate control air conditioner

The powerful air conditioning system provides separate temperature settings for the driver and front passenger.



### Powerful front and rear air flow

The air conditioning system now provides significantly more powerful cooling with top-class air flow that keeps all passengers comfortable even in the hottest weather.

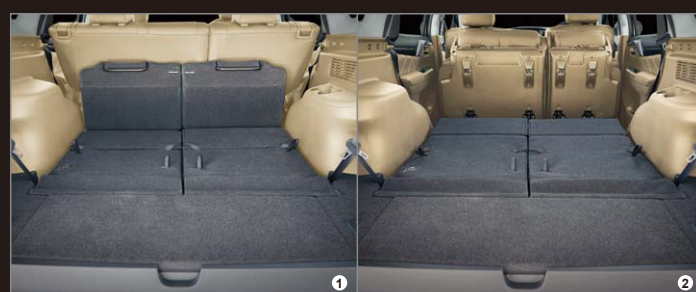

### Cargo space

- 1 Third-row seatbacks folded down
- 2 Second and third-row seatbacks folded down



### Mitsubishi Multi Communication System (MMCS)

The multifunctional navigation system clearly displays navigation and music functions on a big touch panel display with easy-to-use interface. Images from the rear-view camera can also be displayed to enhance driving safety.



### Wide 2DIN AM/FM DVD display audio

Enjoy movies on the high-res 6.1-inch WVGA display and music from your audio player via USB, HDMI or AUX port. Or display views from the rear view camera.



### Wide 2DIN AM/FM CD display audio (redesigned)

Controlling the audio system is easy on the 6.1-inch QVGA touch-panel display, which can also display the views from the rear view camera.



### CD/MP3 player

A quality tuner/CD player and USB port on the floor console enable easy connection with an iPod or other audio player for charging or listening pleasure.

### Genuine Accessories



Note: Actual accessories may vary from those shown or change without notice. Available accessories may vary by market.

## GLX

3.0-liter V6 MIVEC (8A/T)



## GLS H

3.0-liter V6 MIVEC (8A/T)



## GLS Premium Navi Package

3.0-liter V6 MIVEC (8A/T)





## Exterior Colors

**NEW**

White Pearl (W54)



White Solid (W32)



Black Mica (X08)



Sterling Silver Metallic (U25)



Titanium Gray Metallic (U17)



Deep Blue Mica (T64)



Medium Red Mica (P17)



Deep Bronze Metallic (C17)



## Seat Materials And Colors



High quality fabric  
(Water repellent, Beige)



Leather  
(Beige)

## Exterior And Interior Color Combinations

■ Standard — Not available

Grade			GLX		GLS		Premium	Premium DVD Package	Premium Navi Package
				M		H			
Seat materials and colors	High quality fabric (Beige)		■	■	■	■	■	■	■
	Leather (Beige) <b>NEW</b>		—	—	—	■	■	■	■
Exterior colors	White Pearl	W54	—	—	■	■	■	■	■
	White Solid	W32	■	■	—	—	—	—	—
	Black Mica	X08	■	■	■	■	■	■	■
	Sterling Silver Metallic	U25	■	■	■	■	■	■	■
	Titanium Gray Metallic	U17	■	■	■	■	■	■	■
	Deep Blue Mica	T64	■	■	■	■	■	■	■
	Medium Red Mica	P17	■	■	■	■	■	■	■
Deep Bronze Metallic	C17	■	■	■	■	■	■	■	

Note: Colors shown may differ slightly from actual colors due to printing process. Please consult your local Mitsubishi Motors dealer/distributor for actual colors.

## TECHNICAL SPECIFICATIONS

Model	2WD		4WD				
			6B31 MIVEC				
Drive system							
Engine							
Grade	GLX	M	GLS	H	Premium	Premium DVD Package	Premium Navi Package
Model code	KR5WGUMMLW		KS5WGUPMLW				
<b>Dimensions and weights</b>							
Overall length	mm		4785				
Overall width	mm		1815				
Overall height	mm		1800 (W/O roof rails)		1850 (With roof rails)		
Wheelbase	mm		2800				
Track	Front	mm	1520				
	Rear	mm	1515				
Overhang	Front	mm	880				
	Rear	mm	1105				
Min. ground clearance	mm		218				
Curb weight (7-seater)	kg		1880		1980		
Gross vehicle weight	kg		2600				
Seating capacity	persons		5	7	7		
<b>Performance</b>							
Max. speed*	km/h		182				
Climbing ability	tanθ		—		1		
Min. turning radius	m		5.6				
Approach angle	degrees		30.0				
Ramp break-over angle	degrees		23.1				
Departure angle	degrees		24.2				
Wading depth	mm		700				
<b>Engine</b>							
Fuel type/Octane			Unleaded gasoline, RON 95 and over				
Displacement	cc		2,998				
Bore and stroke	mm		87.6 x 82.9				
Compression ratio			9.5				
Emission level			Euro2				
Max. output (EEC net)	kW/rpm		161/6,000				
Max. torque (EEC net)	N·m/rpm		285/4,000				
<b>Electrical and fuel systems</b>							
Battery			80D26L				
Alternator			130A				
<b>Fuel systems</b>							
Fuel supply system			ECI-MULTI				
Fuel tank capacity	liters		70				
<b>Transmission</b>							
Type			8A/T (R8AWG)		8A/T (V8AWG)		
Clutch			Torque converter		Torque converter		
Gear ratio	1st		4.845		4.845		
	2nd		2.840		2.840		
	3rd		1.863		1.863		
	4th		1.436		1.436		
	5th		1.216		1.216		
	6th		1.000		1.000		
	7th		0.815		0.815		
	8th		0.672		0.672		
	Reverse		3.825		3.825		
Transfer gear ratio	High		—		1.000		
	Low		—		2.566		
Final gear ratio		3.917		3.917			
<b>Steering</b>							
Type			Rack and pinion with power steering				
<b>Suspensions</b>							
Front			Independent double wishbone, coil springs with stabilizer bar				
Rear			3-link coil springs with stabilizer bar				
<b>Brakes</b>							
Brake system	Front		Ventilated disc brakes (2POT, Diameter 320mm)				
	Rear		Ventilated disc brakes				
<b>Tires and wheels</b>							
Tires			265/60R18 110H				
Wheels			18X7.5J alloy wheels				

\* Measured by MITSUBISHI MOTORS CORPORATION

Note: These specifications are subject to change without notice. Please consult your local Mitsubishi Motors dealer/distributor for detailed specifications.



STANDARD AND OPTIONAL EQUIPMENT

■ Standard — Not available

Model	Drive system	2WD		4WD					
		GLX	M	GLS	H	Premium	Premium DVD Package	Premium Navi Package	
Model	Trim level / Grade	8A/T		6B31 MIVEC					
	Transmission	8A/T		8A/T					
Model code	Engine	KR5WGUMMLW		KS5WGUPMLW					
	Model code	KR5WGUMMLW		KS5WGUPMLW					
Drivetrain and Chassis	Drivetrain	Sport mode (4-position + manual mode)							
		Super Select 4WD-II (SS4-II)							
		Upgraded silence							
	Suspensions and Differential	Front suspension (independent double wishbone, coil springs, stabilizer bar)							
		Rear suspension (3-link coil springs with stabilizer bar)							
		Rear differential lock (without LSD)							
	Tires and Wheels	Front and rear: 265/60R18 tires with 18" alloy wheels							
		Spare: 265/60R18 tire with 18" alloy wheel							
	Brakes	Front and rear: 265/60R18 tires with 18" alloy wheels <two tone>							
		Spare: 265/60R18 tire with 18" alloy wheel <two tone>							
Electric parking brake									
Anti-lock Brake System (ABS) with Electronic Brake-force Distribution (EBD)									
Brake override system									
Others	Front ventilated discs (2-pot)								
	Rear ventilated discs								
	Cruise control								
	Shift lock with key interlock								
Exterior	Bumpers and Grille	Front (color-keyed, with chrome garnish) and rear (color-keyed) bumper							
		Radiator grille (chrome)							
	Doors	Outer door handles (chrome)							
		Power windows (front and rear doors)							
		(driver's side window: auto down function)							
	Door Mirrors	Door sash blackout							
		Power door mirrors (chrome) with folding function							
	Glass	Power door mirrors (chrome) with folding function and side turn lamp							
		Laminated green windshield glass							
		Windshield sunshade							
Tempered green windows - Front, rear doors and quarter									
Molding	Tempered green tailgate window with defogger								
	Bellline molding (chrome)								
Safety and Security	Others	Side steps (styled grade type with front mudguard function)							
		Front skid plate							
		Engine room undercover							
	Security	Front and rear towing hook, front tie-down hook							
		Rear mudguards (black molded)							
	Airbags	Roof rails (silver)							
		Roof Spoiler							
		Immobilizer							
	Interior	Steering and Shift Knobs	Security alarm						
			Tire Pressure Monitoring System						
Seatbelts		Driver's and front passenger's SRS airbags							
		Driver's SRS knee airbag							
		Driver's and front passenger's SRS side airbags							
Others		SRS curtain airbags for 1st + 2nd + 3rd row seat for 7 seater							
		Front row 3-point seatbelt with ELR x 2 and front adjustable type belt anchors							
Interior		Seatbelts	Seatbelt pretensioner (driver and front passenger)						
			Seatbelt double pretensioner (driver and front passenger)						
		Others	2nd row 3-point seatbelt with ELR x 3						
	3rd row 3-point seatbelt with ELR x 2								
	Others	Ultrasonic misacceleration Mitigation System (UMS)							
		Forward Collision Mitigation system (FCM)							
	Others	Adaptive Cruise Control (ACC)							
		Blind Spot Warning system (BSW)							
	Others	Hill Start Assist (HSA)							
		Brake Assist system (hydraulic)							
Others	Active Stability and Traction Control (ASTC)								
	Hill Descent Control (HDC)								
Others	OFF ROAD MODE								
	Parking sensors (back warning sensors)								
Interior	Steering and Shift Knobs	Tilt and telescopic adjustment							
		4-spoke leather steering wheel							
Interior	Shift Knobs	Paddle shifters							
		Audio switch							
Interior	Shift Knobs	Cruise control switch							
		Hands-free module and switch							
Interior	Shift Knobs	Information display switch							
		Stylish type shift knob for 8 A/T							
Interior	Shift Knobs	Leather transmission shift knob							

Note: Hazardous driving may cause serious injury or vehicle damage. Please drive safely at all times.

STANDARD AND OPTIONAL EQUIPMENT

■ Standard — Not available

Model	Drive system	2WD		4WD					
		GLX	M	GLS	H	Premium	Premium DVD Package	Premium Navi Package	
Model	Trim level / Grade	8A/T		6B31 MIVEC					
	Transmission	8A/T		8A/T					
Model code	Engine	KR5WGUMMLW		KS5WGUPMLW					
	Model code	KR5WGUMMLW		KS5WGUPMLW					
Interior	Seats	Material	High quality fabric seat (water repellent)						
			Leather seat						
	Front row	Manual sliding, single height and reclining function (driver)							
		Manual sliding and reclining function (passenger)							
		Power sliding, dual height and reclining function (driver)							
	2nd row	Convenience hook (driver and passenger)							
		Seatback pocket (driver and passenger)							
	3rd row	6:4 split seat with tumbling and reclining							
		Center armrest with cup holder							
		2nd seat headrest x 3							
Instrument Panel	ISO-FIX child restraint seat anchor x 2, tether anchor x 2								
	5:5 separate seat with folding function								
Air Conditioning and Audio	Floor Console	3rd seat headrest							
		3rd row seatless							
	Door Trims	High console type							
		Garnish and air outlet grille (silver-painted)							
		Air outlet knob (chrome)							
	Others	Center panel (piano black)							
		Center panel (dark-brown woodprint)							
	Others	High contrast meter cluster with chrome garnish and color LCD multi-information display							
		Seatbelt warning indicator and buzzer							
	Others	Glovebox (with key lock, damper and lamp)							
Washer fluid level warning lamp									
Others	Cigarette lighter								
	High console type with armrest (cloth covered)								
Others	High console type with armrest (PVC covered)								
	Cup holder for front seat x 2								
Others	Accessory socket in floor console box								
	Console panel (piano black)								
Others	Console panel (dark-brown woodprint)								
	Formed type with cloth insert								
Others	Formed type with PVC insert								
	Bottle holder								
Others	Accent panel (piano black)								
	Accent panel (dark-brown woodprint)								
Others	Inner door handles (chrome)								
	Center door locking system and center door lock button (Driver's seat)								
Others	Child proof								
	Vehicle-speed sensitive automatic door lock (with impact sensitive unlock mechanism)								
Others	Keyless entry system with 2 transmitters								
	Keyless Operation System (with engine start switch)								
Others	Sunroof								
	Sunglasses pocket								
Others	Headlining formed type (knit)								
	Sunvisor (vanity mirror with lid, ticket holder on driver's side)								
Others	Retractable assist grip x 5 (front, 2nd, 3rd rows) and coat hook (2nd row) x 2								
	Retractable assist grip x 6 (front, 2nd, 3rd rows) and coat hook (2nd row) x 2								
Others	Retractable assist grip x 3 (front, 2nd rows) and coat hook (2nd row) x 2								
	Auto dimming rear view mirror								
Others	Cargo room hook x 2								
	Cargo room hook x 4								
Others	Cargo floor box								
	Full automatic air conditioner								
Others	Dual-zone automatic climate control air conditioner								
	Rear cooler								
Others	Wide 2-DIN AM/FM and CD player								
	Wide 2-DIN touch-panel display audio (AM/FM and CD)								
Others	Wide 2-DIN AM/FM DVD display audio with HDMI / USB port								
	Wide 2-DIN Navigation system (Mitsubishi Multi Communication System [MMCS])								
Others	Multi-Around Monitor								
	Rear view camera								
Others	USB port								
	6 speakers (2 tweeters)								
Others	Roof antenna								
	Glass antenna								
Others	80D26L								
	Halogen headlamps								
Others	LED headlamps with auto leveling device and LED daytime running lamps								
	LED rear combination lamps								
Others	Daytime running lamp on bumper								
	Front foglamps								
Others	LED high-mount stop lamp on tailgate								
	Room lamp with map lamp and rear room lamp x 2								
Others	Front and Rear door courtesy lamps								
	Cargo room lamps								
Others	Front and rear intermittent wipers and washers								
	Headlamp washers								